

Univers Revers™ Shoulder System

Humeral Preparation Surgical Technique

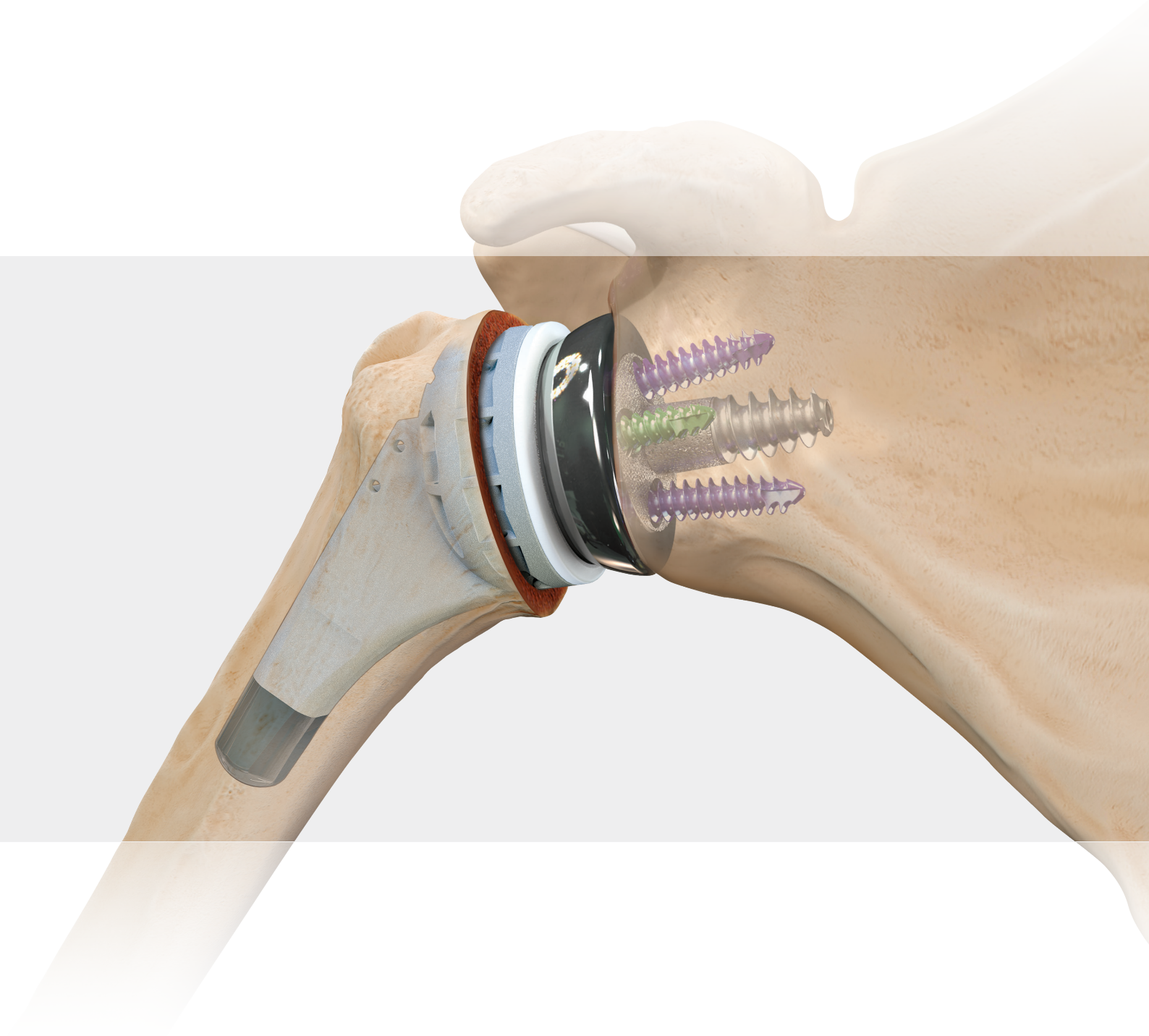

Implant Design Rationale

As an essential component of the Arthrex family of shoulder arthroplasty and fracture-management products, the Univers Revers™ total shoulder system is designed to restore function to shoulders with advanced cartilage disease in the presence of irreparable rotator cuff defects. The Univers Revers feature set and its design flexibility help optimize joint mechanics and deltoid tension for each patient.

Supporting intraoperative decision-making was vital to the design group. The system employs humeral implant features such as multiple inclination angles and cup sizes, metaphyseal offset, options for attaching the rotator cuff and tuberosity fragments to the prosthesis, and options for liner/spacer tensioning. Arthrex understands surgery is about decisions and options.

System Features

Humeral Stems

- 135° and 155° inclination angles in one universal stem body
- Rectangular proximal filling stem based on anatomic geometry of Univers™ II total shoulder system
- Calcium phosphate (HA or CaP)-coated proximal stem
- 1 mm size increments for optimized press-fit
- Traditional-length stems from 95 mm to 147 mm
- Univers Revers Apex stems from 60 mm to 65 mm



SutureCups, Liners, and Spacers



- 33 mm, 36 mm, 39 mm, and 42 mm options
- Suture holes for tuberosity and rotator cuff attachment
- Calcium phosphate (CaP)-coated cup
- Centered and offset options for bone preservation and anatomic placement
- 2 polyethylene liners and 4 titanium spacer thicknesses for optimal soft-tissue balancing
- Standard and constrained liner options
- Adapters available for revision to anatomic hemi-shoulder replacement with Cuff Arthropathy (CA) humeral head

Preoperative Planning

Preoperative planning may have a significant impact on the surgical outcome, especially if it is overlooked. Quality shoulder radiographs should include true A/P, axillary lateral, and supraspinatus outlet views. Technicians should use a reproducible process that generates images with consistent and predictable magnification for templating. The Univers Revers™ total shoulder system includes a set of templating transparencies for glenoid and humeral component sizing. Additional radiographic studies, such as CT and MRI to evaluate glenoid geometry and soft-tissue quality, respectively, complement a thorough diagnostic workup. With a CT study, the Virtual Implant Positioning™ (VIP™) system can be used to accurately plan and execute glenoid component implantation.

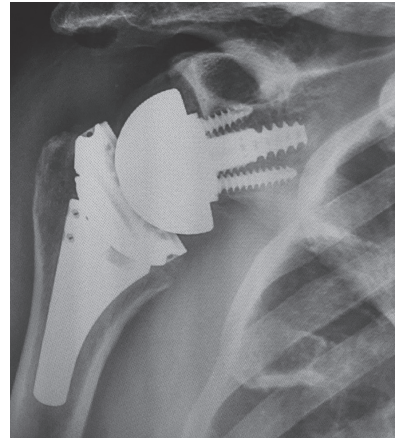

Univers Revers Apex
Implant (**135° Inclination**)

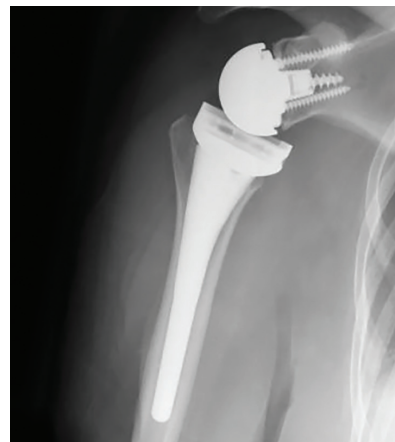

Univers Revers Implant
(**155° Inclination**)



Preoperative Proximal
Humeral Fracture

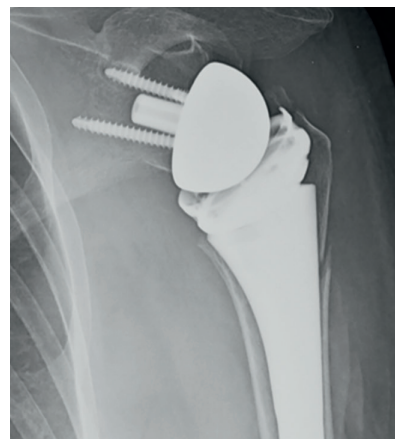

Postoperative Fracture
Repair With Univers Revers
Implant (**135° Inclination**)

Humeral Head Resection



Establish the intramedullary entry point posterior to the bicapital groove. Make the initial entry point with the 2.4 mm guide pin, followed by a cannulated 6 mm drill to open up the hole in preparation for the IM reamer. Advance the IM reamer to the depth mark and leave it in the canal.

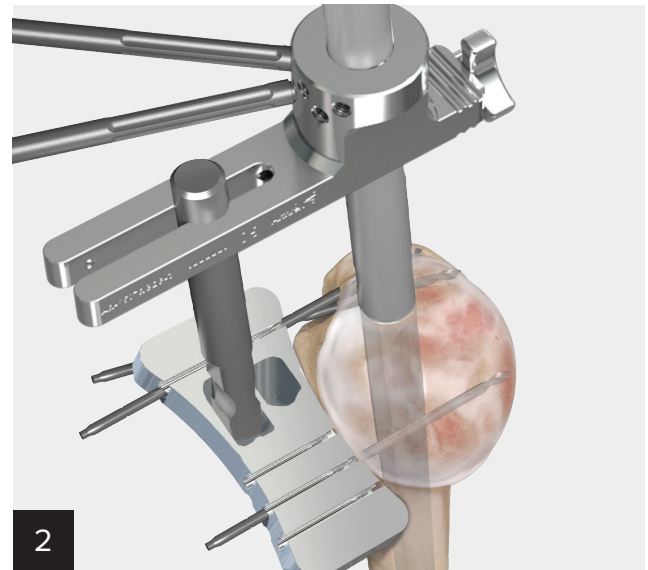

Fix the resection guide/resection block assembly at the desired angle (135° or 155°) and position on the IM reamer. Advance the osteotomy guide pins into the humeral head to secure the resection guide/resection block. Remove the IM reamer and assembly, leaving the resection block in position.

Note: Optional version rods can be attached to the resection guide assembly at 0°, 20°, and 40° to cross-check the resection block position.

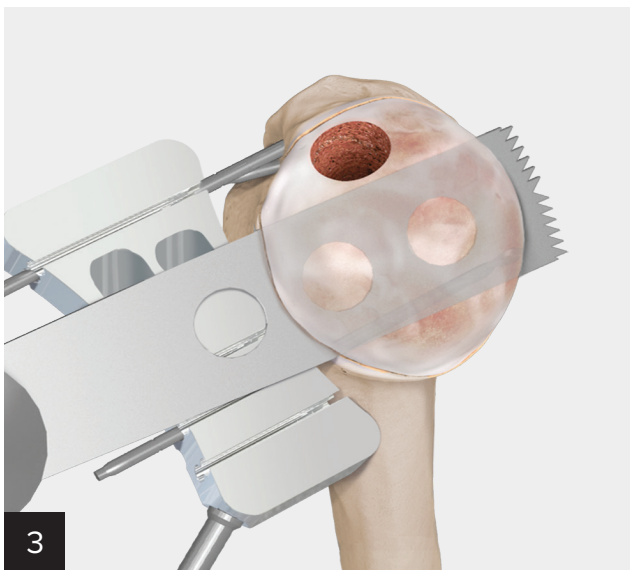

Resect the humeral head using the resection block to guide the oscillating saw blade.

Note: The glenoid drill guide handle can be secured to the resection block for stabilization purposes, if desired.

Glenoid Preparation and Implantation



Remove the resection block and osteotomy guide pins. Impact the resection Protector™ device onto the resected humeral surface.

Note: The humeral protector device size can be used to estimate metaphyseal cup size and glenosphere size (XS = 33 mm, S = 36 mm, M = 39 mm, L = 42 mm).

Prepare and implant the glenoid per the chosen technique:

- Uniers Revers™ Modular Glenoid System (LT1-00112-EN-US)
- Uniers Revers Augmented Modular Glenoid System (LT1-000169-EN-US)
- Universal Glenoid™ Convertible Baseplate (LT1-000000-EN-US)

SutureCup Glenosphere Matrix

		Glenosphere Size				
		33 mm	36 mm	39 mm	42 mm	45 mm
SutureCup Size	33 mm	Standard Liner	33/36 mm Combo Liner			
	36 mm	36/33 Combo Liner	Standard Liner	36/39 Combo Liner		
	39 mm			Standard Liner	39/42 Combo Liner	
	42 mm				Standard Liner	42/45 Combo Liner

Combo and standard inserts are available constrained

For use only with the Modular Glenoid System

For use with the Modular Glenoid System and Universal Glenoid convertible baseplate

Humeral Preparation



The Uniers Revers system can be used with a traditional-length stem or the short Uniers Revers Apex stem. The steps for the Uniers Revers Apex stem are shown below. If using the traditional-length Uniers Revers stem, the steps are similar with subtly different instruments; most notably, the broach is sized with the stem length.

Reream the IM canal by advancing the IM reamers to the depth mark. It is recommended not to exceed the 8 mm reamer during this step, as cortical chatter need not be achieved based on stem geometry.

Note: If being used in a fracture, progressive IM reaming past 8 mm is acceptable.

Humeral Preparation for the Univers Revers™ Implant

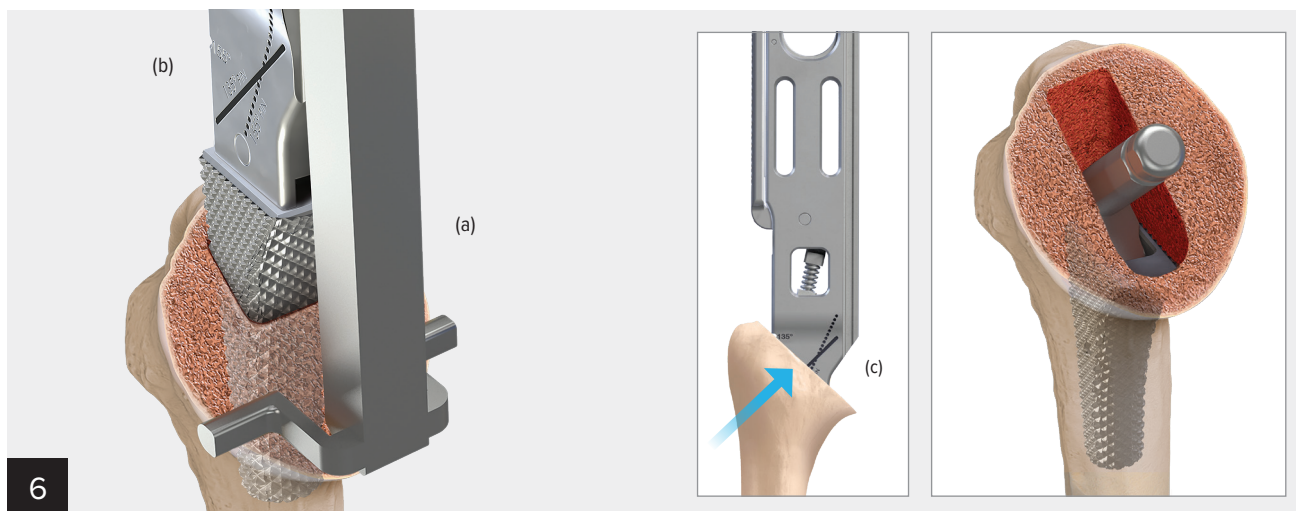

Attach the broach handle to the 6 mm broach.

Note: In smaller patients, a 4 or 5 mm monoblock broach should be considered. Both stem sizes are available in a 135° configuration.

Note: A modular size 5 stem is also available in a 135° configuration and is matched to its own modular broach.

Connect the broach alignment guide (a) to the broach handle (b). Progressively broach to the desired fit. The broach depth mark (135° and 155°) represents the minimum impaction line. The laser-marked lines

(c) represent the location of the reamer guide pin, which should approximate the center of the resection plane. Disconnect the handle and leave the broach in the IM canal. Check the A/P position of the broach and choose the appropriate central or offset reamer guide pin. Insert the reamer guide pin into the broach.

Note: Version rods can be attached to the modular broach handle at 0°, 20°, and 40°.

Note: When using the 4 or 5 mm monoblock stems, there are dedicated stem trials with integral reaming guide pins.

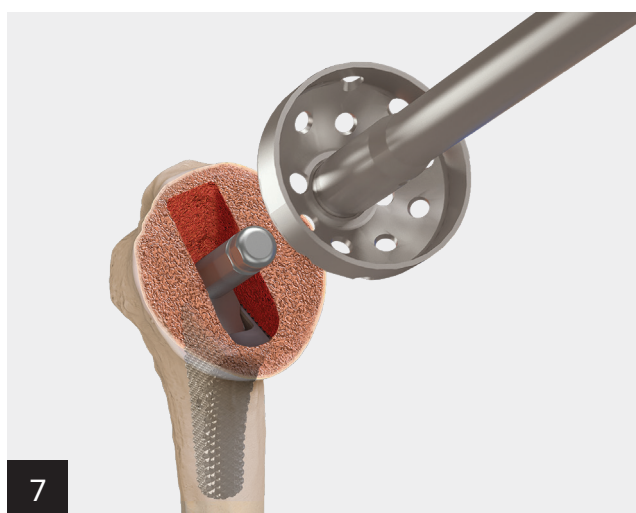

Visualize the reamer pin in the broach and select the appropriate size humeral cup reamer. The reamer guide pin provides a positive stop to ream to the proper depth.

Note: An alternate technique (shown on the following page) should be considered in cases of poor bone quality when using the 4 monoblock stem.



Once reaming is complete, remove the reamer guide pin and leave the broach in position. Connect the corresponding humeral trial cup (angle, diameter, and offset) to the broach.

Note: The 4/33 monoblock stem has a corresponding 4/33 monoblock trial. The trial can be removed with the impactor/extractor handle (AR-9512).

Humeral Preparation for the Univers Revers™ Implant: 4 Monoblock Alternate Technique



Mark the humeral head as shown at the midway point of the resection plane. This line will denote the final M/L position of the reaming pin (AR-9510-04-135, see inset) and the center of the cup in the definitive implant.



If the IM reamer was not previously used to facilitate head resection, insert the 5 mm IM reamer (AR-9202-25H) into the humeral canal laterally.

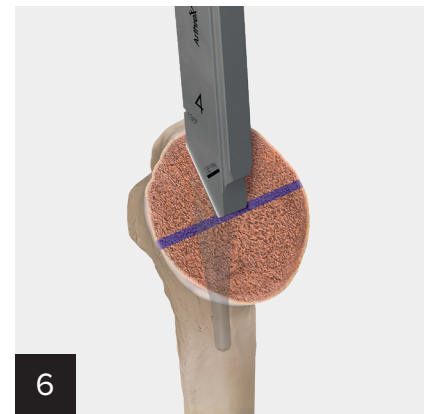

Impact the 4 monoblock broach (AR-9510-04M) until the medial edge of the broach contacts the transverse line made in step 5, taking care to align version as desired.

Note: If the bone quality is exceptionally poor, omit the broach and proceed to the next step. If desired, use a rongeur to create a path from the reamer entry point to the line bisecting the resection plane to facilitate insertion of the reaming pin.

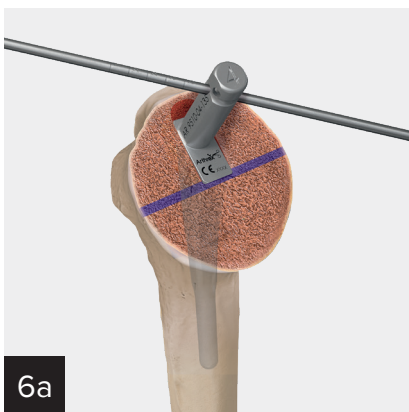

Place the 4 monoblock reaming pin (AR-9510-04-135) in the prepared humerus as shown. A 2.8 mm pin can be inserted as shown (right orientation pictured) if desired. The pin is set to 30° of retroversion.

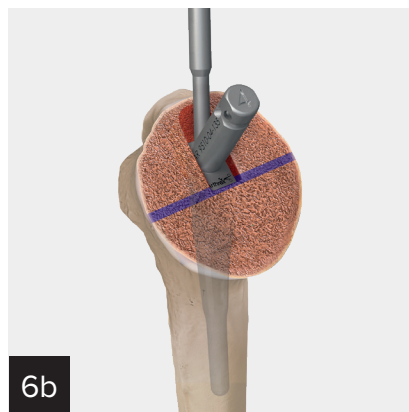

If the bone quality allows, push the reaming pin distally by hand, taking care to keep the version and inclination angles constant. If the bone provides sufficient resistance to prevent the manual advancement of the pin, engage the pointed impactor (AR-9202-09) with the dimple on the lateral shoulder of the reaming pin and gently impact the pin.



Once the center of the reaming pin is bisected by the transverse line made in step 5 (as pictured above), proceed to step 7 and carry out the remainder of the technique as described in the subsequent steps.

Humeral Preparation for the Univers Revers™ Implant



Connect the trial humeral liners and spacers as needed for soft-tissue balancing. Polyethylene liner implants are available in 3 mm and 6 mm; titanium spacer implants are available in +6 mm, +9 mm, +12 mm, and +15 mm.

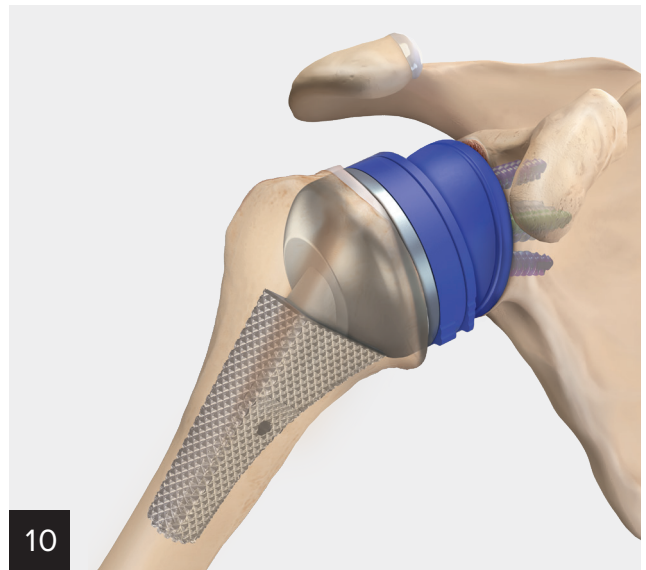

Reduce the trial to assess stability and ROM.

Note: Spacers should be used only in combination with +3 mm liners.

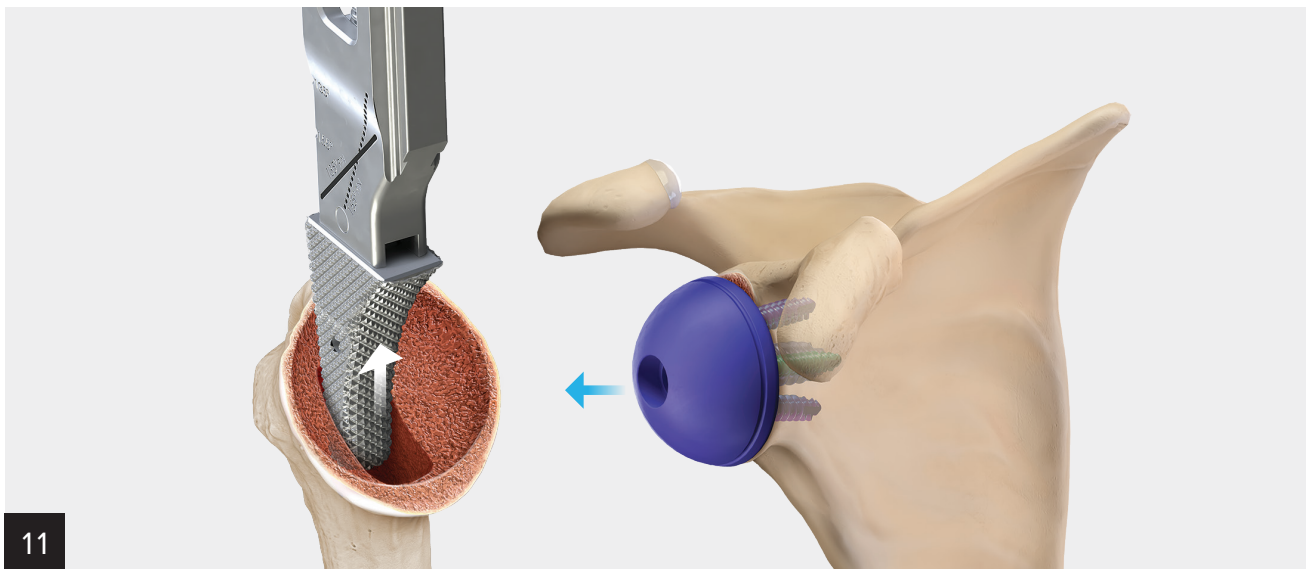

Once adequate tension has been achieved, remove the humeral components. The humeral broach can be removed using the broach handle or the threaded extractor/impactor handle and the slotted mallet.

Remove the glenosphere trial and insert the glenosphere implant per the Univers Revers Modular Glenoid System Surgical Technique (LT1-00112-EN).

Humeral Stem Assembly and Implantation



12

Assemble the definitive humeral stem and SutureCup based on the previously determined angles and trial sizes.

First, place the stem into the appropriate slot on the humeral assembly station and place the humeral cup screw guide into the cup (inset).



13

Insert the post/screw of the SutureCup into the appropriate slot of the stem (135° or 155°) as shown (inset). These instruments ensure the screwdriver is properly aligned with the axis of the screw. Tighten the screw to at least **3 Nm** with the short modular T-15 screwdriver, torque-indicating adapter, and ratcheting handle.

Note: Torque must not exceed 5 Nm.

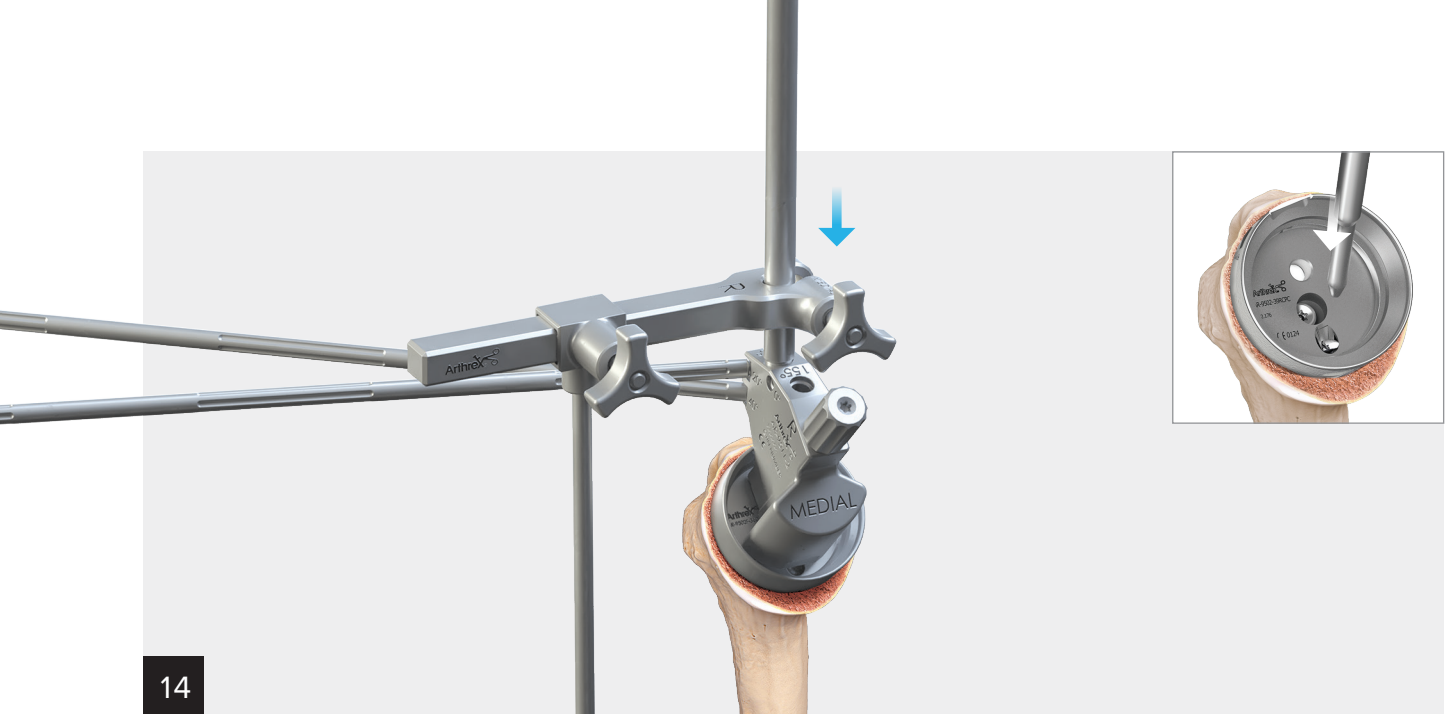

14

Thread the impactor/extractor adapter into the SutureCup. Then thread the impactor/extractor handle into the proximal hole of the adapter based on the chosen inclination angle. Impact the components into the humerus. Once fully seated, uncouple the adapter from the SutureCup by unscrewing the thumb screw.

When using the Univers Revers Apex, attach the external alignment guide as shown for visual reference to the humerus and to avoid varus or valgus insertion.

Alternatively, when using the traditional-length stem, the pointed impactor can be used to seat the implant (inset).

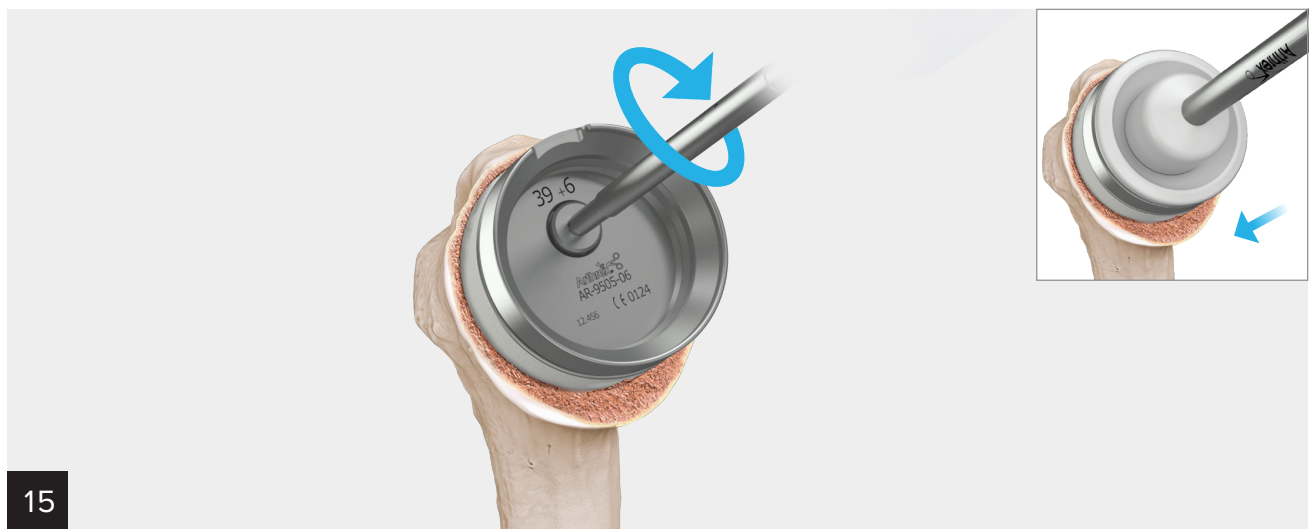

15

A second trial reduction should be performed with the trial liner, trial spacer (if applicable), and definitive glenosphere. After proper stability and ROM are assessed, connect the definitive titanium spacer (if required) with the short modular T-15 screwdriver, torque-indicating adapter, and ratcheting handle. Tighten the screw to at least 3 Nm. Last, impact the liner (inset).

Note: Torque must not exceed 5 Nm. Spacers should be used only in combination with +3 mm liners.

Final Reduction and Closure

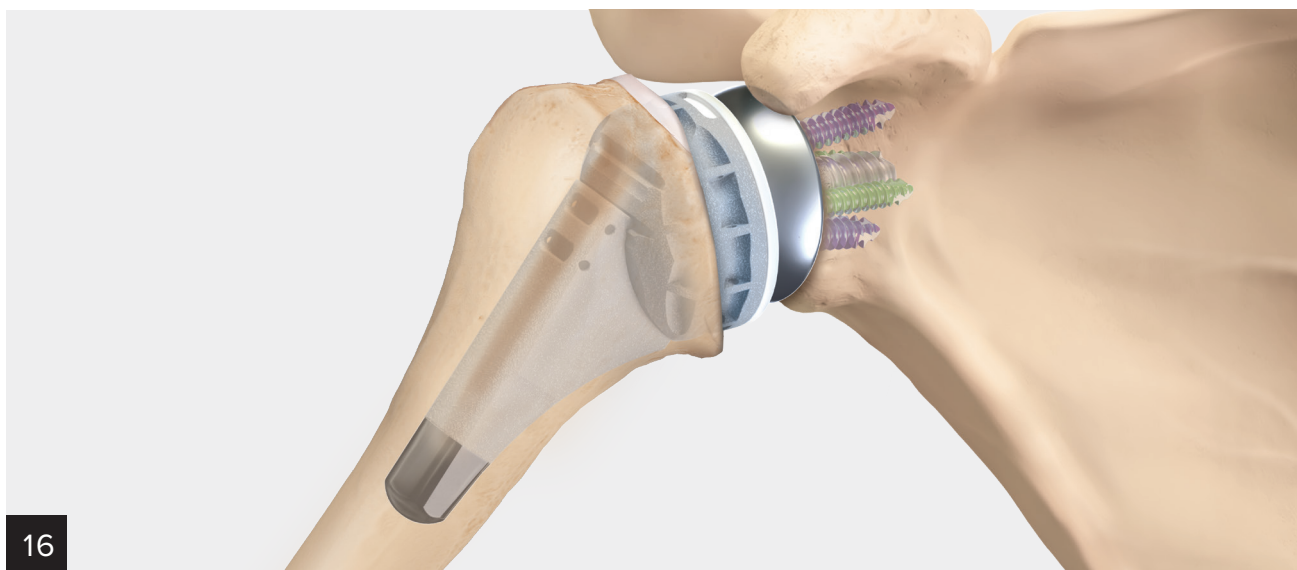

Reduce the shoulder and complete wound closure.

Humeral Implant Removal

There are multiple options for removing the humeral components of the Unvers Revers™ system, as depicted below.

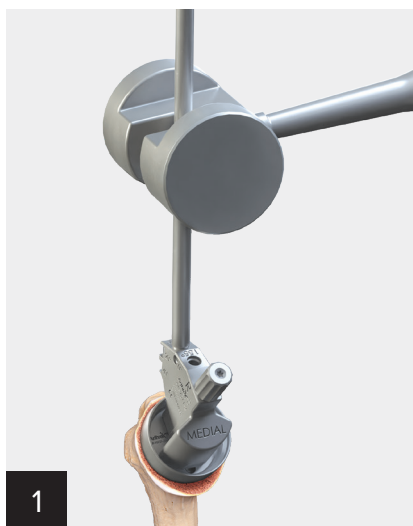

Once the liner is removed, if only a small amount of bony growth is evident or the stem is loose, assemble the impactor/extractor adapter and handle to the SutureCup and then use the slotted mallet to remove the entire assembly.

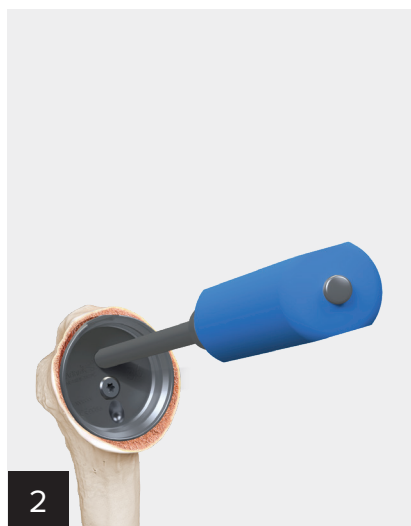

With more growth around the SutureCup, thread the impactor/extractor handle directly to the cup and lever to assist in detaching the SutureCup from the bone. In some cases, the construct can be removed with the handle in this orientation.



For cases in which there is substantial bony growth to the Unvers Revers stem, remove the SutureCup by loosening the screw and pass the osteotomes along the flat surfaces to loosen the stem. Then thread the impactor/extractor handle directly to the stem prior to using the slotted mallet for removal.

Conversion to CA (Cuff Arthropathy) Humeral Head



Remove the glenoid components and reverse humeral liner. Place the trial CA adapter on the SutureCup as shown. The trial CA adapter can also be placed directly onto a humeral spacer if it is already implanted. Size the CA adapter and corresponding trials with the SutureCup. Note the size matrix below for compatibility of the CA head sizes.

Use a rongeur or saw to remove any excess bone at the tuberosities. This is critical to establishing clearance for the lateral flange of the CA head and to ensure that the implant seats properly.

Compatibility Matrix: Unvers Revers™ CA Heads With CA Adapters

		Unvers Revers Total Shoulder System CA Heads			
		40/17	44/17	50/19	56/22
Unvers Revers CA Adapters	33 mm	✓	✓	✓	✓
	36 mm	✗	✓	✓	✓
	39 mm	✗	✗	✓	✓
	42 mm	✗	✗	✓	✓

✓ Compatible ✗ Not Compatible



3 Use trials to assess joint tension and range of motion. In addition to CA head and CA adapter trials, the humeral spacer trial (inset) may be used.

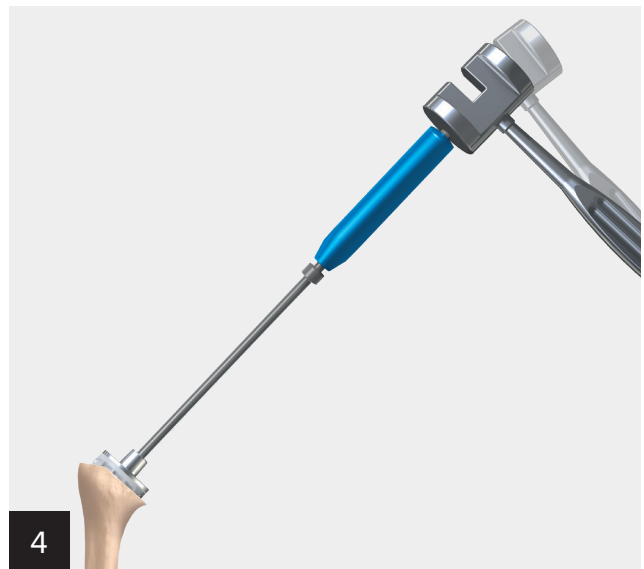

4 After selecting the appropriately sized implants, thread the stem/cup impactor handle securely to the CA adapter. Then impact the implant onto the Univers Revers™ SutureCup, taking care to ensure the tab of the CA adapter is aligned with the lateral slot of the SutureCup.

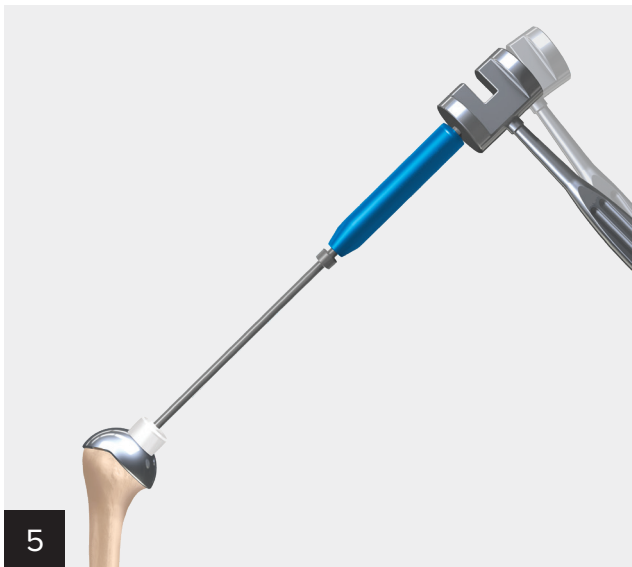

Impact the CA head with the liner/glenosphere impactor.

Note: While the “hood” of the Univers Revers CA head is intended to be placed laterally, if the inclination of the SutureCup is set at 155°, it may be preferable to rotate the CA head 180°, placing the “hood” medially.

This may allow for optimized medial (and lateral) coverage with the head. Using the trial CA head will help in making this determination.

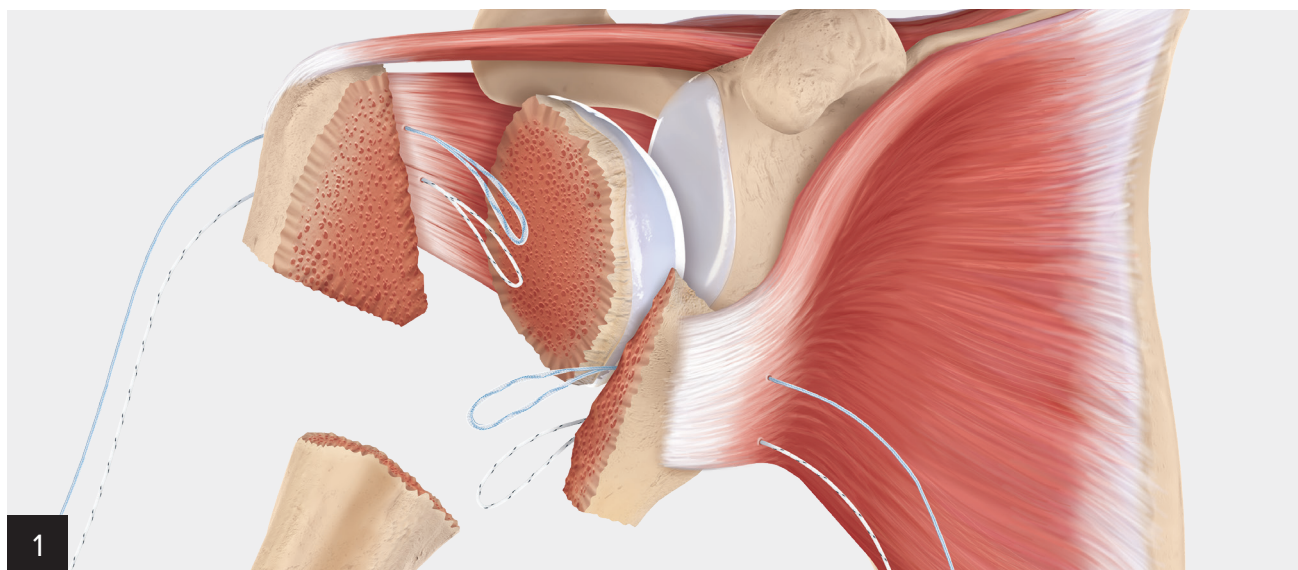

Identify the proximal humeral fracture pattern (a 4-part fracture in this example). Gain control of the lesser tuberosity fragment by passing #2 FiberLink™ suture (blue) and #2 TigerLink™ suture (black/white) at the subscapularis bone/tendon junction. Using the free needle in the kit, pass the #2 FiberLink suture in an inside-out manner through the superior portion of the subscapularis tendon.

Repeat this process with the #2 TigerLink suture going through the inferior portion of the subscapularis tendon.

Identify the greater tuberosity and remaining rotator cuff. Using the free needle in the kit, pass the #2 FiberLink suture inside-out through the infraspinatus tendon at the bone-tendon junction. Repeat this process with the #2 TigerLink suture going through the intersection of the infraspinatus and teres minor tendons. It is important to ensure the greater tuberosity fragment and remaining rotator cuff are dissected free of adhesions.

#2 FiberLink sutures provide traction to aid in humeral head removal and glenoid exposure. Once the lesser and greater tuberosity fragments are dissected free of adhesions, remove the humeral head fragment from the wound.

Note: The #2 looped FiberLink and TigerLink sutures will be used later in the case for shuttling tuberosity repair sutures.

1.3 mm SutureTape is provided in the kit. The 1.3 mm SutureTape can be used as supplemental traction sutures or at the end for rotator interval closure.

Following exposure of the glenoid, prepare the glenoid per the Unvers Revers™ Modular Glenoid System (LT1-00112-EN), Augmented Modular Glenoid System (LT1-000169-en-US), or Universal Glenoid™ System (LT1-000000-en-US) surgical technique.

Once the glenoid components are implanted, prepare and trial the humeral components in accordance with the Unvers Revers™ Shoulder System surgical technique (LT1-0703-EN).

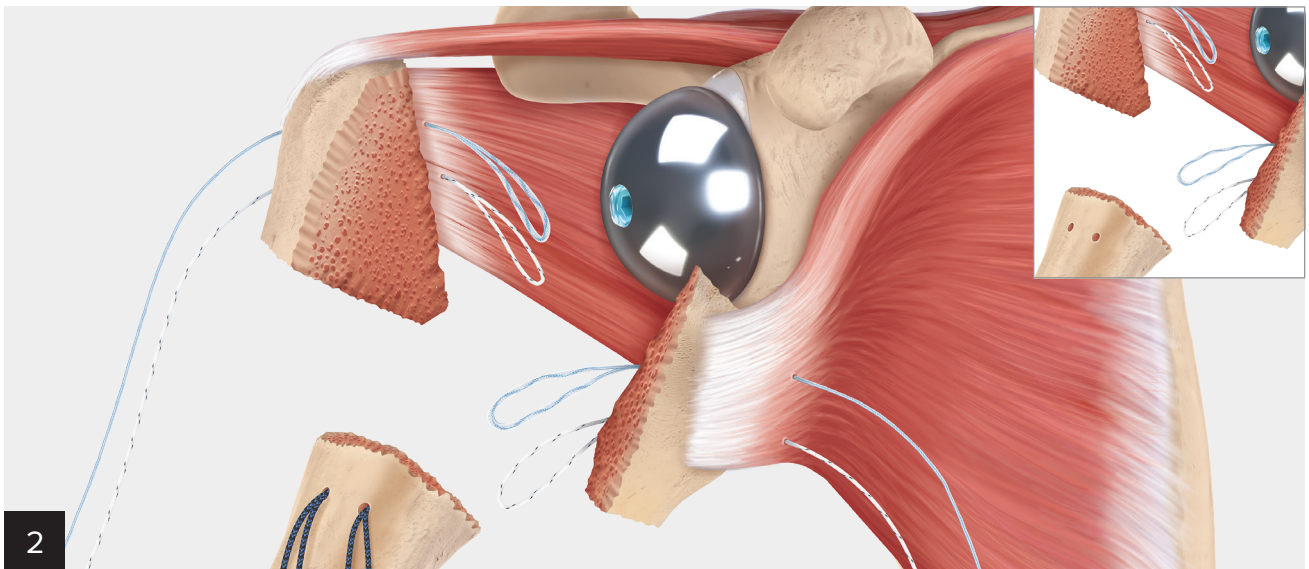

2 Remove the humeral trials. Drill two holes on the lateral side of the bicipital groove with the 2.0 mm drill bit (see inset). Drill the holes 1-2 cm distal to the humeral shaft fracture line.

Working anterior to posterior, pass the 1.7 mm FiberTape® sutures (black/blue) in an outside-in, then inside-out fashion.



3 After assembling the SutureCup and humeral stem per the Univers Revers™ Shoulder System Humeral Preparation surgical technique, pass the 1.7 mm FiberTape suture (blue) through two eyelets of the proximal row of the SutureCup. Then, pass the 1.7 mm TigerTape™ suture (white/black) through the two eyelets medial to the previously passed suture on the proximal row. Repeat suture passing for the posterior SutureCup eyelets.

4 Implant the humeral prosthesis per the Univers Revers™ Shoulder System surgical technique (LT1-0703-EN). Perform a trial reduction and assess range of motion (ROM). Place the final humeral insert.

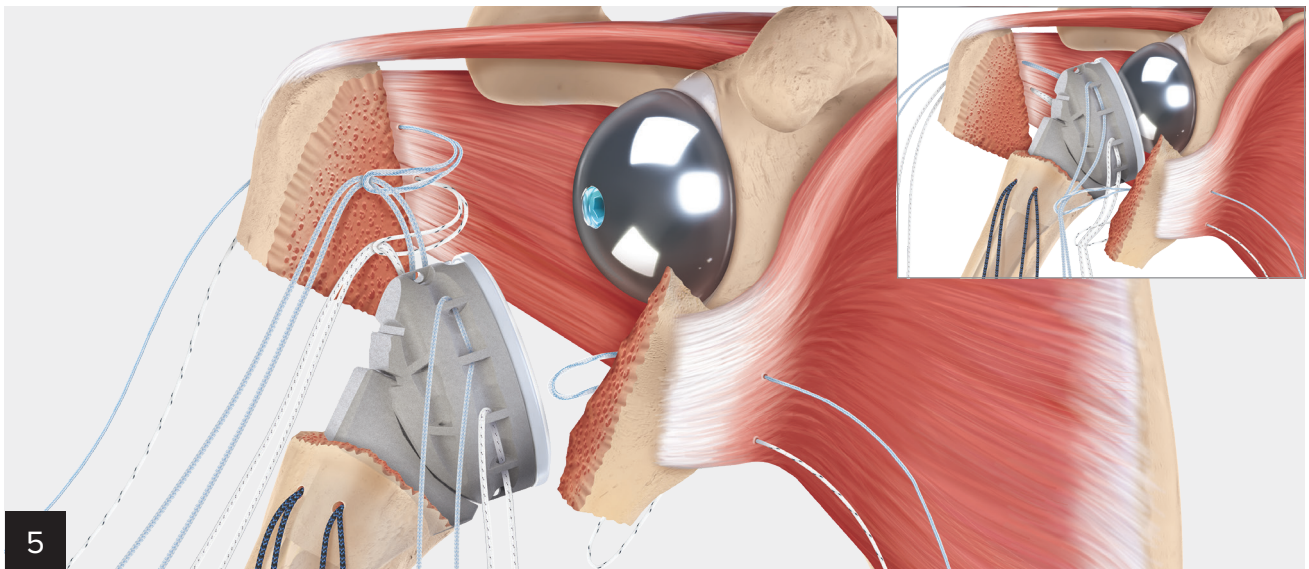

5 Use the #2 FiberLink™ sutures placed earlier in the case to pull traction on the greater tuberosity fragment. Take the suture tails from 1.7 mm FiberTape® suture (blue) and feed them into the looped end of the #2 FiberLink suture. Shuttle the suture through the greater tuberosity fragment.

Repeat the previous steps for the 1.7 mm TigerTape™ and #2 TigerLink™ sutures. Reduce the shoulder.

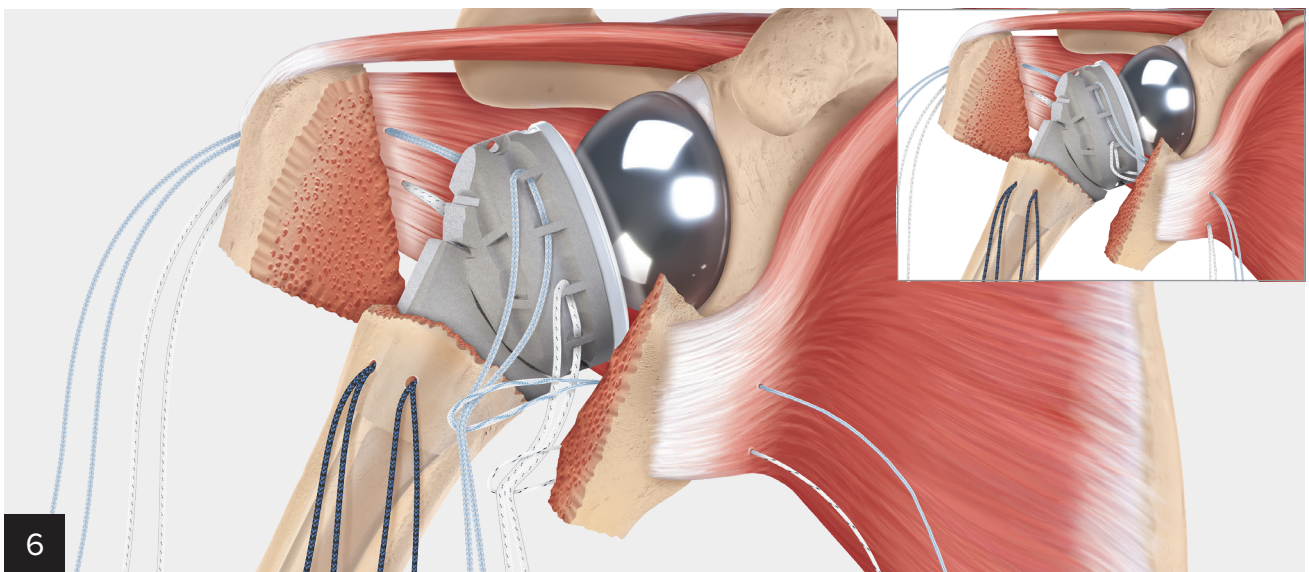

6 Use the #2 FiberLink sutures placed earlier in the case to pull traction on the lesser tuberosity fragment. Take the suture tails from 1.7 mm FiberTape™ suture (blue) and feed them into the #2 FiberLink™ suture looped end. Shuttle the suture through the subscapularis.

Repeat the previous steps for the 1.7 mm TigerTape™ and #2 TigerLink™ sutures.

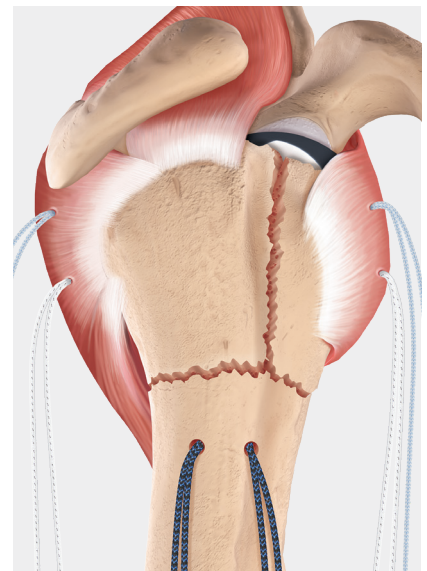
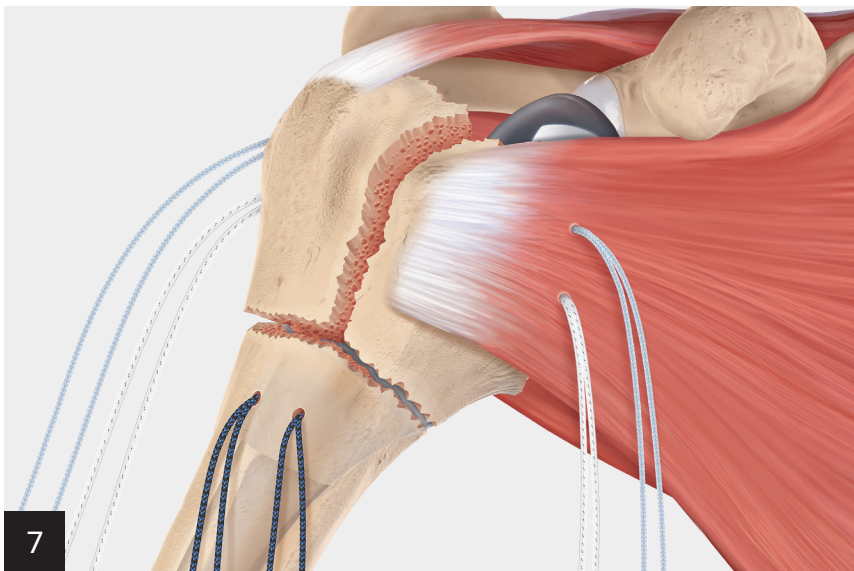

Reduce and repair the tuberosities.

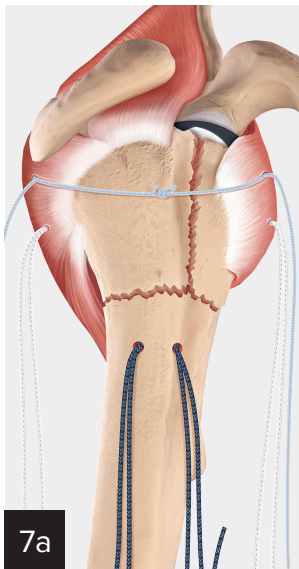

Take one limb of the 1.7 mm FiberTape™ suture (blue) from the lesser tuberosity and one limb of the 1.7 mm FiberTape suture (blue) from the greater tuberosity and tie them together.

Note: These sutures are sliding. There is no need to tension the sutures at this point.

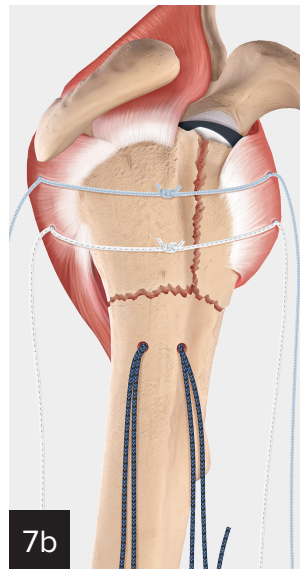

Take one limb of the 1.7 mm TigerTape™ suture (white/black) from the lesser tuberosity and one limb of the 1.7 mm TigerTape suture (white/black) from the greater tuberosity and tie them together.

Note: These sutures are sliding. There is no need to tension the sutures at this point.

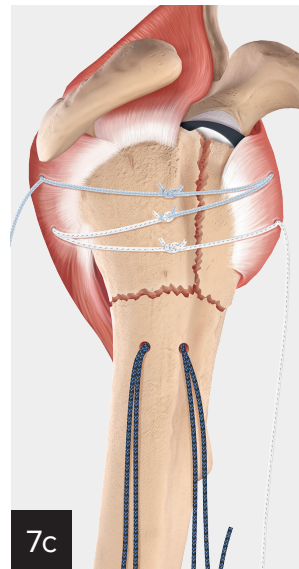

Take the remaining 1.7 mm FiberTape suture (blue) from the lesser tuberosity and the remaining 1.7 mm TigerTape suture from the greater tuberosity and tie them together. Tensioning is required.

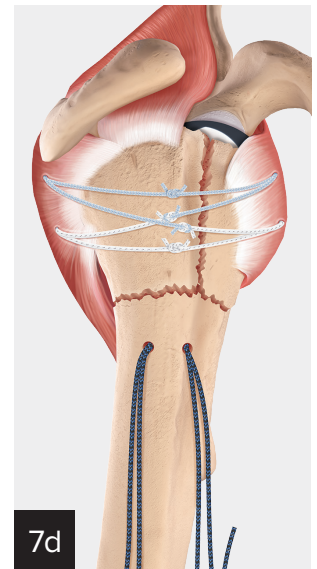

Take the remaining 1.7 mm TigerTape suture (white/black) from the lesser tuberosity and the remaining 1.7 mm FiberTape suture from the greater tuberosity and tie them together. Tensioning is required.

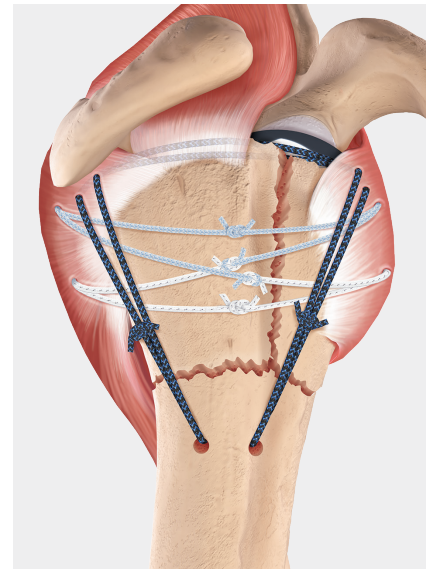
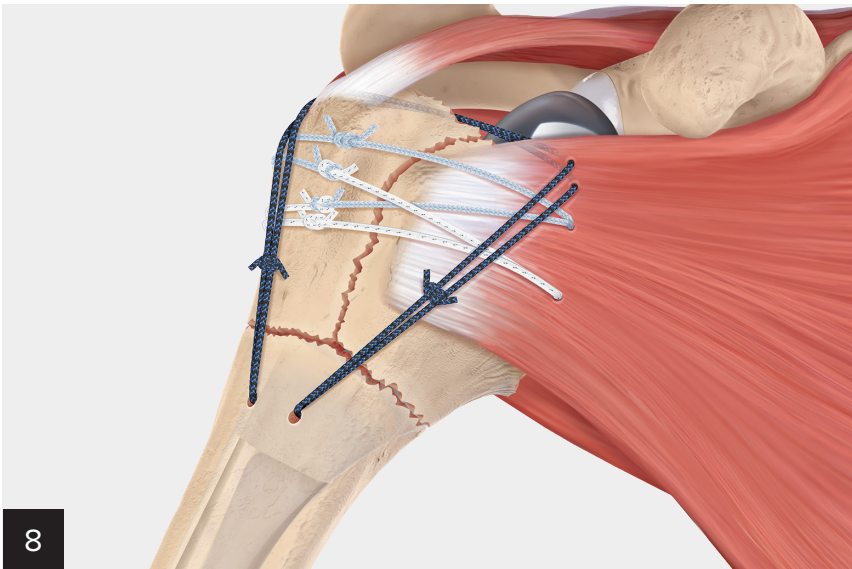

After the suture construct has been tied, begin to pass and tie the vertical tension band sutures.

1. Pass a posterior limb of the 1.7 mm FiberTape™ suture (black/blue) up through the infraspinatus and down through the subscapularis. Tie on the anterior side.
2. Pass the remaining anterior limb of the 1.7 mm FiberTape suture (black/blue) up through the subscapularis and down through the infraspinatus. Tie on the posterior side.

Check range of motion and complete wound closure.

Wound Closure

Prior to closure, assess stability and mobility with the final implants in place. Thoroughly irrigate the wound before closure, removing any remaining soft tissue and bone debris. Obtain hemostasis with electrocautery. Assess hemostasis and, if excessive bleeding is found, place a single hemovac wound drainage device into the deep layer. If possible in a primary reverse total shoulder replacement, repair the subscapularis while

monitoring external rotation. Repair the deltoid and pectoralis major muscles with a side-to-side closure using #1 absorbable suture. Repair the subcutaneous layer with 2-0 interrupted absorbable suture. Finally, use a 3-0 suture for skin closure, supporting it with Steri-Strip™ skin closures. Secure the hemovac drain, if used, and initiate suction. The drain is usually removed on the first postoperative day.

Ordering Information

Humeral Implants

Product Description	Item Number
Univers Revers Stem, size 4/33, monoblock 135°	AR-9501-04-135P
Univers Revers Stem, size 5/36, monoblock 135°	AR-9501-05-135CPC
Univers Revers Stem, size 5/36, monoblock 155°	AR-9501-05-155CPC
Univers Revers Stem, size 5, modular	AR-9501-05P
Univers Revers Stem, size 6	AR-9501-06P
Univers Revers Stem, size 7	AR-9501-07P
Univers Revers Stem, size 8	AR-9501-08P
Univers Revers Stem, size 9	AR-9501-09P
Univers Revers Stem, size 10	AR-9501-10P
Univers Revers Stem, size 11	AR-9501-11P
Univers Revers Stem, size 12	AR-9501-12P
Univers Revers Stem, size 13	AR-9501-13P
Univers Revers Apex Stem, size 6	AR-9501-06S
Univers Revers Apex Stem, size 7	AR-9501-07S
Univers Revers Apex Stem, size 8	AR-9501-08S
Univers Revers Apex Stem, size 9	AR-9501-09S
Univers Revers Apex Stem, size 10	AR-9501-10S
Univers Revers Apex Stem, size 11	AR-9501-11S
Univers Revers Apex Stem, size 12	AR-9501-12S
Univers Revers Apex Stem, size 13	AR-9501-13S
Univers Revers Apex Stem, size 14	AR-9501-14S
Univers Revers Apex Stem, size 15	AR-9501-15S
Univers Revers SutureCup, 33 (neutral)	AR-9502F-33CPC
Univers Revers SutureCup, 33 (+2 mm left)	AR-9502F-33LCPC
Univers Revers SutureCup, 33 (+2 mm right)	AR-9502F-33RCPC
Univers Revers SutureCup, 36 (neutral)	AR-9502F-36CPC
Univers Revers SutureCup, 36 (+2 mm left)	AR-9502F-36LCPC
Univers Revers SutureCup, 36 (+2 mm right)	AR-9502F-36RCPC
Univers Revers SutureCup, 39 (neutral)	AR-9502F-39CPC
Univers Revers SutureCup, 39 (+2 mm left)	AR-9502F-39LCPC
Univers Revers SutureCup, 39 (+2 mm right)	AR-9502F-39RCPC
Univers Revers SutureCup, 42 (neutral)	AR-9502F-42CPC
Univers Revers SutureCup, 42 (+2 mm left)	AR-9502F-42LCPC
Univers Revers SutureCup, 42 (+2 mm right)	AR-9502F-42RCPC
Humeral Liner, 42 +3 mm	AR-9503L-03
Humeral Liner, 42 +3 mm, constrained	AR-9503L-03C
Humeral Liner, 42 +6 mm	AR-9503L-06
Humeral Liner, 42 +6 mm, constrained	AR-9503L-06C
Humeral Liner, 39 +3 mm	AR-9503M-03
Humeral Liner, 39 +3 mm, constrained	AR-9503M-03C
Humeral Liner, 39 +6 mm	AR-9503M-06
Humeral Liner, 39 +6 mm, constrained	AR-9503M-06C
Humeral Liner, 36 +3 mm	AR-9503S-03
Humeral Liner, 36 +3 mm, constrained	AR-9503S-03C

Product Description	Item Number
Humeral Liner, 36 +6 mm	AR-9503S-06
Humeral Liner, 36 +6 mm, constrained	AR-9503S-06C
Humeral Liner, 33 +3 mm	AR-9503XS-03
Humeral Liner, 33 +3 mm, constrained	AR-9503XS-03C
Humeral Liner, 33 +6 mm	AR-9503XS-06
Humeral Liner, 33 +6 mm, constrained	AR-9503XS-06C
33 +3 mm Combination humeral Liner for 36 Glenosphere	AR-9503-3336-3
33 +6 mm Combination humeral Liner for 36 Glenosphere	AR-9503-3336-6
33 +3 mm Constrained Combination Humeral Liner for 36 Glenosphere	AR-9503-3336-3C
33 +6 mm Constrained Combination Humeral Liner for 36 Glenosphere	AR-9503-3336-6C
36 +3 mm Humeral Insert for 33 Glenosphere	AR-9503-3633-3
36 +6 mm Humeral Insert for 33 Glenosphere	AR-9503-3633-6
36 +3 mm Constrained Humeral Insert for 33 Glenosphere	AR-9503-3633-3C
36 +6 mm Constrained Humeral Insert for 33 Glenosphere	AR-9503-3633-6C
36 +3 mm / 39 Combination Humeral Insert	AR-9503-3639-3
36 +6 mm / 39 Combination Humeral Insert	AR-9503-3639-6
36 +3 mm / 39 Constrained Combination Humeral Insert	AR-9503-3639-3C
36 +6 mm / 39 Constrained Combination Humeral Insert	AR-9503-3639-6C
39 +3 mm / 42 Combination Humeral Insert	AR-9503-3942-3
39 +6 mm / 42 Combination Humeral Insert	AR-9503-3942-6
39 +3 mm / 42 Constrained Combination Humeral Insert	AR-9503-3942-3C
39 +6 mm / 42 Constrained Combination Humeral Insert	AR-9503-3942-6C
42 +3 mm / 45 Combination Humeral Insert	AR-9503-4245-3
42 +6 mm / 45 Combination Humeral Insert	AR-9503-4245-6
42 +3 mm / 45 Constrained Combination Humeral Insert	AR-9503-4245-3C
42 +6 mm / 45 Constrained Combination Humeral Insert	AR-9503-4245-6C
Humeral Spacer, 39 +6 mm	AR-9505-06
Humeral Spacer, 39 +9 mm	AR-9505-09
Humeral Spacer, 39 +12 mm	AR-9505-12
Humeral Spacer, 39 +15 mm	AR-9505-15
Humeral Spacer, 42 +6 mm	AR-9550-06
Humeral Spacer, 42 +9 mm	AR-9550-09
Humeral Spacer, 42 +12 mm	AR-9550-12
Humeral Spacer, 42 +15 mm	AR-9550-15
Humeral Spacer, 36 +6 mm	AR-9555-06

Humeral Implants

Product Description	Item Number
Humeral Spacer, 36 +9 mm	AR-9555-09
Humeral Spacer, 36 +12 mm	AR-9555-12
Humeral Spacer, 36 +15 mm	AR-9555-15
Humeral Spacer, 33 +6 mm	AR-9504-06
Humeral Spacer, 33 +9 mm	AR-9504-09
Humeral Spacer, 33 +12 mm	AR-9504-12
Humeral Spacer, 33 +15 mm	AR-9504-15

Revers CA Implants

Product Description	Item Number
Revers CA Adapter, 33 mm	AR-9502-33ARCA
Revers CA Adapter, 36 mm	AR-9502-36ARCA
Revers CA Adapter, 39 mm	AR-9502-39ARCA
Revers CA Adapter, 42 mm	AR-9502-42ARCA
Revers CA Humeral Head, 40/17	AR-9540-17RCA
Revers CA Humeral Head, 44/17	AR-9544-17RCA
Revers CA Humeral Head, 50/19	AR-9550-19RCA
Revers CA Humeral Head, 56/22	AR-9556-22RCA

Consumables

Product Description	Item Number
Univers Revers™ Sterile Pin Set	AR-9507S
Drill Tip Guide Pin, 2.4 mm	AR-1250L
Guidewire, 2.8 mm	AR-9165K
Osteotomy Guide Pin, 2.4 mm, qty. 2	AR-13303-2.4
FxBridge™ Tuberosity Repair System	AR-9517

Special Order Implants

Product Description	Item Number
Univers Revers Stem, size 14	AR-9501-14P
Univers Revers Stem, size 15	AR-9501-15P
Univers Revers Stem, size 6, revision (180 mm)	AR-9501-06RCPC
Univers Revers Stem, size 9, revision (180 mm)	AR-9501-09RCPC
Univers Revers Stem, size 12, revision (180 mm)	AR-9501-12RCPC

Special Order Instruments

Product Description	Item Number
Large Humeral (14/15 mm) Instrument Set	AR-9501LHS
IM Reamer, 14 mm	AR-9202-34H
IM Reamer, 15 mm	AR-9202-35H
Broach/Trial, 14 mm	AR-9510-14
Broach/Trial, 15 mm	AR-9510-15
Large Humeral Stem Instrument Case	AR-9501LHC

Optional

Product Description	Item Number
Humeral Resection Block, 135°/155° (Superolateral)	AR-9507RGS�-1
Superolateral Version Guide Adapter	AR-9507RGS�-2
Univers Revers Reduction Tool	AR-9545

Revision Humeral Instrument Set (AR-9501RHS)

Product Description	Item Number
IM Reamer, 6 mm, revision	AR-9506-06R
IM Reamer, 9 mm, revision	AR-9506-09R
IM Reamer, 12 mm, revision	AR-9506-12R
Broach/Trial, 6 mm, revision	AR-9510-06R
Broach/Trial, 9 mm, revision	AR-9510-09R
Broach/Trial, 12 mm, revision	AR-9510-12R
Revision Stem Instrument Case	AR-9501RHC

Literature

Product Description	Item Number
Shoulder Implant Identification Card	LC1-0700-EN
Univers Revers™ Modular Glenoid System Technique	LT1-00112-EN
Univers Revers™ Augmented Modular Glenoid System Technique	LT1-000169-en-US
Universal Glenoid™ Convertible Baseplate Technique	LT1-000000-en-US

Implant Templates

Univers Revers X-ray Templates	AR-703
Univers Revers Apex X-ray Templates	AR-703S

Products may not be available in all markets because product availability is subject to the regulatory approvals and medical practices in individual markets. Please contact your Arthrex representative if you have questions about the availability of products in your area.

Humeral Instrument Set 1

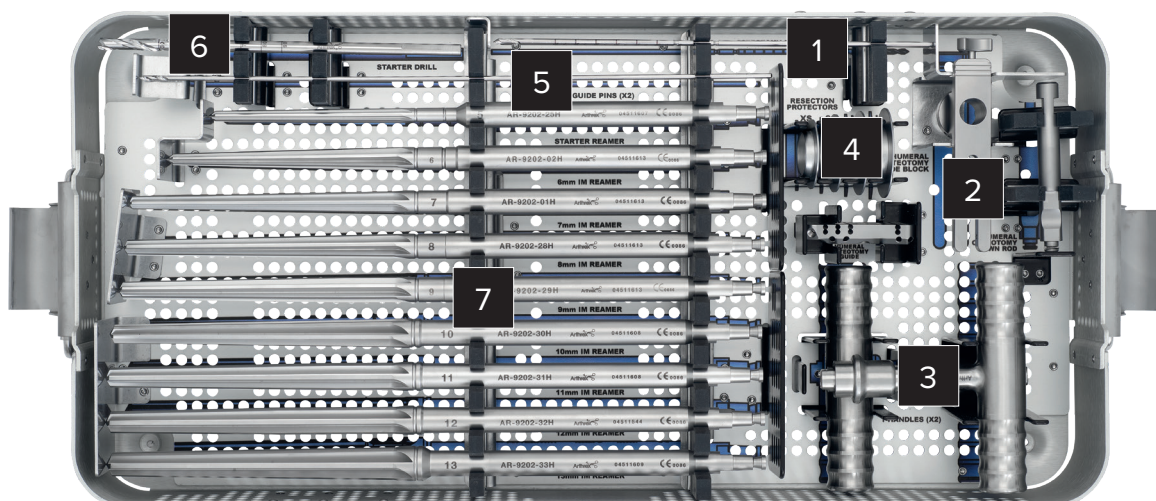

Humeral Instrument Set 1 - (AR-9501HS-1)

Pic.	Item Number	Qty.	Product Description
1	AR-13303-2.4	4	Osteotomy Guide Pin
2	AR-9507RGDP	1	Humeral Resection Guide Assembly
3	AR-9202-15H	2	Universal T-Handle
4	AR-9509-XS/S/M/L	1 each	Humeral Resection Protectors
5	AR-1250L	2	2.4 mm Guidewires
6	AR-1206L	1	Cannulated Drill, 6 mm
7	AR-9202-xxH	1 each	IM Reamers, 5 mm-13 mm

Humeral Broach Set

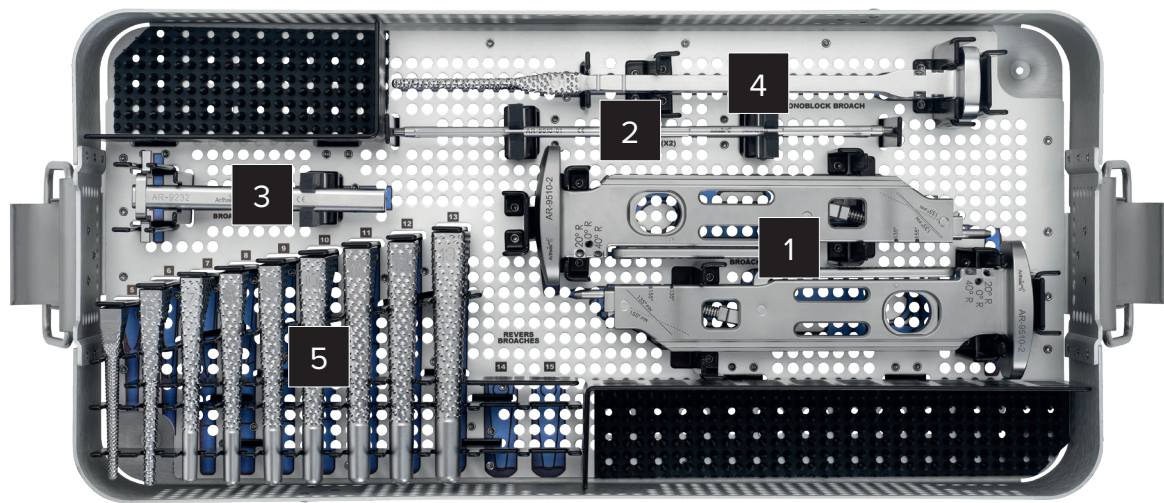

Humeral Broach Set - (AR-9501HBS)

Pic.	Item Number	Qty.	Product Description
1	AR-9510-2	2	Lever-Lock Broach Handle
2	AR-9510-01	2	Version Rod
3	AR-9232	1	Humeral Broach Alignment Guide

Pic.	Item Number	Qty.	Product Description
4	AR-9510-05 or AR-9510-04M	1	Univers Revers Humeral Broach, size 5/36 or 4/33 monoblock
5	AR-9510-XX	1 each	Revers Humeral Broaches, sizes 5-13

Humeral Instrument Set 2

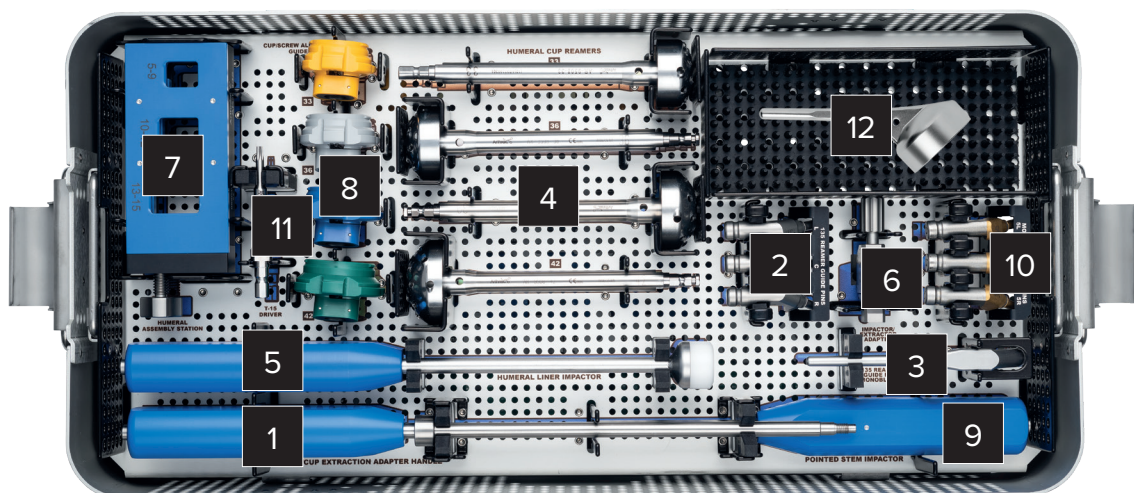

Humeral Instrument Set 2 - Top Tray (AR-9501HS-2)

Pic.	Item Number	Qty.	Product Description
1	AR-9512	1	Stem/Cup Impactor/Extractor Handle
2	AR-9510RG-C/R/L	1 each	Univers Modular Reamer Pins, 135°
3	AR-9510-05-135 or AR-9510-04-135	1	Univers Revers Reamer Guide, size 5/36 135° or size 4/33 135°
4	AR-9508-33/36/39/42	1 each	Humeral Cup Reamers
5	AR-9531	1	Liner/Glenosphere Impactor
6	AR-9511-2	1	Humeral Impactor/Extractor Adapter
7	AR-9532	1	Assembly Stand
8	AR-9532-33/36/39/42	1 each	Cup Screw Alignment Guides
9	AR-9202-09	1	Pointed Impactor
10	AR-9510RG-5C/5R/5L	1 each	Univers Revers Reamer Guides, size 5 modular
11	AR-9545-T15-01	1	T15 Driver Shaft, short
12	AR-9523-04-135	1	Univers Revers Trial Stem, size 4/33 135°

Humeral Instrument Set 2

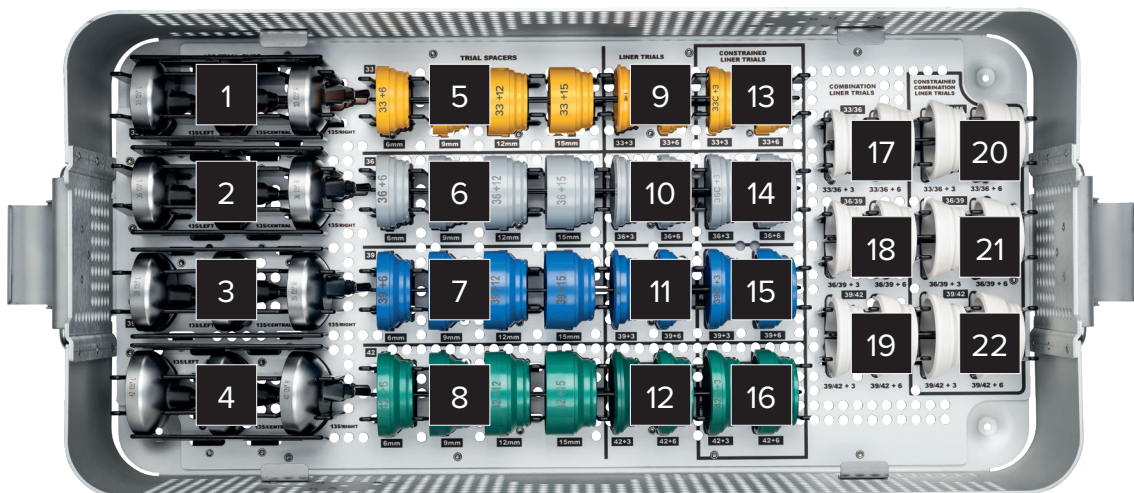

Humeral Instrument Set 2 - Bottom Tray (AR-9501HS-2)

Pic.	Item Number	Qty.	Product Description
1	AR-9523-135/135R/135L	1 each	135° Trial Cups, 33 mm
2	AR-9522-135/135R/135L	1 each	135° Trial Cups, 36 mm
3	AR-9520-135/135R/135L	1 each	135° Trial Cups, 39 mm
4	AR-9521-135/135R/135L	1 each	135° Trial Cups, 42 mm
5	AR-9554-06/09/12/15	1 each	Trial Spacers, 33 mm
6	AR-9551-06/09/12/15	1 each	Trial Spacers, 36 mm
7	AR-9552-06/09/12/15	1 each	Trial Spacers, 39 mm
8	AR-9553-06/09/12/15	1 each	Trial Spacers, 42 mm
9	AR-9530XS-03/06	1 each	Trial Liners, 33 mm
10	AR-9530S-03/06	1 each	Trial Liners, 36 mm
11	AR-9530M-03/06	1 each	Trial Liners, 39 mm
12	AR-9530L-03/06	1 each	Trial Liners, 42 mm
13	AR-9530XS-03C/06C	1 each	Constrained Trial Liners, 33 mm
14	AR-9530S-03C/06C	1 each	Constrained Trial Liners, 36 mm
15	AR-9530M-03C/06C	1 each	Constrained Trial Liners, 39 mm
16	AR-9530L-03C/06C	1 each	Constrained Trial Liners, 42 mm
17	AR-9603-3336-3/6	1 each	Combo Liners 33 mm/36 mm
18	AR-9603-3639-3/6	1 each	Combo Liners 36 mm/39 mm
19	AR-9603-3942-3/6	1 each	Combo Liners 39 mm/42 mm
20	AR-9603-3336-3C/6C	1 each	Constrained Combo Liners 33 mm/36 mm
21	AR-9603-3639-3C/6C	1 each	Constrained Combo Liners 36 mm/39 mm
22	AR-9603-3942-3C/6C	1 each	Constrained Combo Liners 39 mm/42 mm



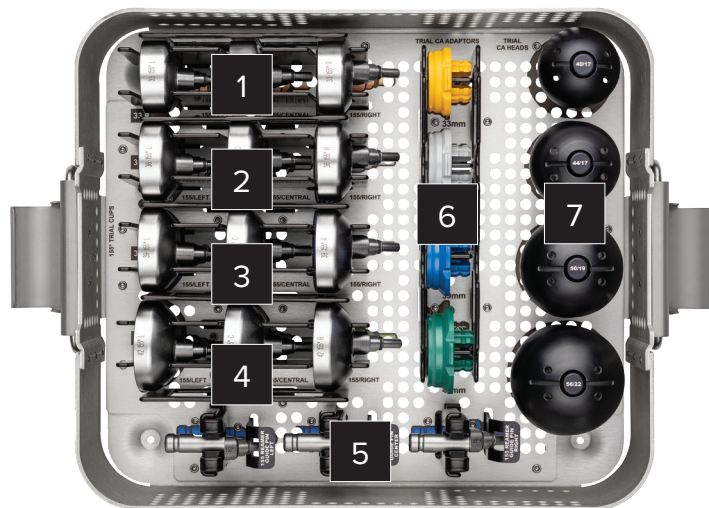

Univers Revers™ CA Head and Adapter Trials



Univers Revers CA Head and Adapter Trials - (AR-9501H-CA155S)

Pic.	Item Number	Qty.	Product Description
1	AR-9523-155/155R/155L	1 each	155° Trial Cups, 33 mm
2	AR-9522-155/155R/155L	1 each	155° Trial Cups, 36 mm
3	AR-9520-155/155R/155L	1 each	155° Trial Cups, 39 mm
4	AR-9521-155/155R/155L	1 each	155° Trial Cups, 42 mm
5	AR-9511RG-C/R/L	1 each	Univers Modular Reamer Pins, 155°
6	AR-9522-33ARCAT AR-9522-36ARCAT AR-9522-39ARCAT AR-9522-42ARCAT	1	Univers Revers CA Trial Adapter, 33 mm Univers Revers CA Trial Adapter, 36 mm Univers Revers CA Trial Adapter, 39 mm Univers Revers CA Trial Adapter, 42 mm
7	AR-9540-17RCAT AR-9544-17RCAT AR-9550-19RCAT AR-9556-22RCAT	1	Univers Revers CA Trial Head, 40/17 mm Univers Revers CA Trial Head, 44/17 mm Univers Revers CA Trial Head, 50/19 mm Univers Revers CA Trial Head, 56/22 mm

Univers Revers™ Implant Compatibility Matrix

	Stem	Univers Revers Apex (Short): 6 mm-15 mm Univers Revers (Standard): 4 mm*-15 mm Revision: 6 mm, 9 mm, 12 mm *4 mm – Monoblock 135° with 33 mm cup only 5 mm – Monoblock 135° and 155° options with 36 mm cup only											
	Cup Can be fixed at inclination angle of 135° or 155°	33 Left	33	33 Right	36 Left	36	36 Right	39 Left	39	39 Right	42 Left	42	42 Right
Optional	 Spacer In combination with +3 mm liners only	33 6, 9, 12, 15 mm (for 6 mm - 15 mm stems) (for 5 mm Modular)			36 6, 9, 12, 15 mm (for 5 mm - 15 mm stems)			39 6, 9, 12, 15 mm (for 6 mm-15 mm stems) (for 5 mm Modular)			42 6, 9, 12, 15 mm (for 6 mm-15 mm stems) (for 5 mm Modular)		
	Liner	33 +3 +6	36 +3 +6	33 +3 +6	36 +3 +6	39 +3 +6	39 +3 +6	42 +3 +6	42 +3 +6	42 +3 +6	45 +3 +6	45 +3 +6	45 +3 +6

All liner sizes are also available constrained

Uniers Revers Implant Key Dimensions

Liner	Spacer	SutureCup
Std +3 mm, +6 mm Const +3 mm, +6 mm	+6 mm, +9 mm, +12 mm, +15 mm	Neutral, +2 mm R, +2 mm L

135°, 155°
33 mm, 36 mm, 39 mm, 42 mm

Stem Dimensions (mm)

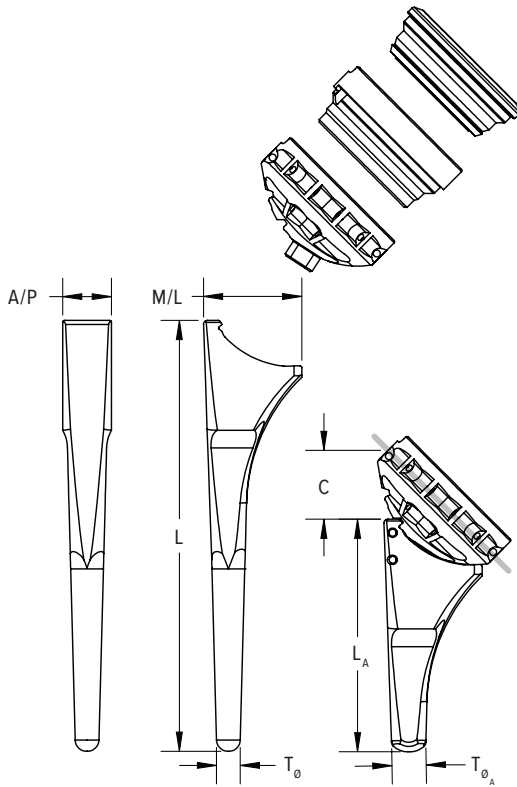

Stem Size	Length, L, L _A , L _{Rev}	Additional Length From Cup	T ₀ , T _{0A}	A/P	M/L
4 (Mono)	78	C ₁₃₅ = 19	5.7	10	17.4
5 (Mono)	95, -, -	C ₁₅₅ = 12 C ₁₃₅ = 19	5.5, -	12.6	20.5 (155°) 22.0 (135°)
5 (Modular)	99, -, -	C ₁₅₅ = 10 C ₁₃₅ = 18	5.5, 7.2	11.5	23.3
6	111, 60, 180		6.0, 8.9	12.6	25.4
7	115, 60, -		7.8, 9.8	12.6	25.4
8	119, 60, -		8.7, 10.8	12.6	26.4
9	123, 60, 180		9.5, 11.8	12.6	27.4
10	127, 60, -		10.4, 12.8	14.5	28.4
11	131, 60, -		11.2, 13.8	14.5	29.3
12	135, 60, 180		12.0, 14.7	14.5	30.3
13	139, 65, -		13.0, 15.7	17.5	31.4
14	143, 65, -		13.8, 16.7	17.5	32.4
15	147, 65, -	14.6, 17.7	17.5	33.3	

Indications

Univers Revers™ Shoulder Prosthesis System

The Univers Revers shoulder prosthesis system is indicated for use in a grossly rotator cuff deficient glenohumeral joint with severe arthropathy or a previously failed joint replacement with a gross rotator cuff deficiency. The patient's joint must be anatomically and structurally suited to receive the selected implant(s), and a functional deltoid muscle is necessary to use the device.

The Univers Revers shoulder prosthesis system is indicated for primary, fracture, or revision total shoulder replacement for the relief of pain and significant disability due to gross rotator cuff deficiency. (Note: The Univers Revers shoulder prosthesis is not indicated for fracture in CE Accepting Countries.)

(Humeral) Stems are intended for cemented or cementless applications for use with Arthrex humeral suture cups. The Universal Glenoid baseplate is CaP coated and is intended for cementless use with the addition of screws for fixation.

Univers Revers Modular Glenoid System

The Univers Revers Modular Glenoid System is indicated for use in a grossly rotator cuff deficient glenohumeral joint with severe arthropathy or a previously failed joint replacement with a gross rotator cuff deficiency. The patient's joint must be anatomically and structurally suited to receive the selected implant(s), and a functional deltoid muscle is necessary to use the device.

The Univers Revers Modular Glenoid System is indicated for primary, fracture, or revision total shoulder replacement for the relief of pain and significant disability due to gross rotator cuff deficiency.

The Univers Revers Modular Glenoid System is porous coated and is intended for cementless use with the addition of screws for fixation.

The Univers Revers Modular Glenoid System glenosphere made of titanium is indicated for patients with suspected cobalt alloy sensitivity. The wear properties of titanium and titanium alloys are inferior to that of cobalt alloy. A titanium humeral head is not recommended for patients who lack suspected material sensitivity to cobalt alloy. (Note: In CE Accepting Countries, the Univers Revers Modular Glenoid System is not indicated for fracture and the glenosphere made of titanium is not available.)

Univers Revers CA Humeral Head and Adapters

The Univers Revers CA humeral head and adapters are indicated for:

- salvage of a failed reverse total shoulder, with an irreparable rotator cuff tear and a well-fixed humeral stem, to an anatomic hemi-shoulder replacement; or
- conversion of a primary reverse total shoulder, for the relief of pain secondary to severe rotator cuff arthropathy and an irreparable rotator cuff tear, to anatomic hemi-shoulder replacement when insufficient glenoid bone stock is encountered intraoperatively after the humeral stem has been implanted.

The patient's joint must be anatomically and structurally suited to receive the selected implant(s), and a functional deltoid muscle is necessary to use the device.

Contraindications

1. Insufficient quantity or quality of bone.
2. Blood supply limitations and previous infections, which may retard healing.
3. Foreign body sensitivity. Where material sensitivity is suspected, appropriate tests should be made and sensitivity ruled out prior to implantation.
4. Any active infection or blood supply limitations.
5. Conditions that tend to limit the patient's ability or willingness to restrict activities or follow directions during the healing period.
6. Do not use for surgeries other than those indicated.

Warnings

1. Caution: Federal law restricts this device to sale by or on the order of a physician.
2. This device is intended to be used by a trained medical professional.
3. An internal fixation device must never be re-used.
4. 6mm offset humeral liners must not be used in combination with humeral spacers. Humeral spacers should only be used with 3mm offset humeral liners.
5. Failure to achieve the appropriate torque requirements when tightening locking screws may result in the premature loosening of the device.
6. Postoperatively and until healing is complete, fixation provided by this device should be considered as temporary and may not withstand weight bearing or other unsupported stress. The fixation provided by this device should be protected. The postoperative regimen prescribed by the physician should be strictly followed to avoid adverse stresses applied to the device.

7. Detailed instructions on the use and limitations of this device, the patient leaflet (www.arthrex.com/patientleaflets) and the patient implant card should be given to the patient. Your surgeon will guide you in deciding what particular treatment is best for you and explain the benefits, risks, and contraindications associated with the treatment.
8. Any decision to remove the device should take into consideration the potential risk to the patient of a second surgical procedure. Device removal should be followed by adequate postoperative management.
9. Removal of the device should be performed using standard surgical practices for device removal.
10. Pre-operative and operating procedures, including knowledge of surgical techniques and proper selection and placement of the implant, are important considerations in the successful utilization of this device. The following operative situations may cause premature loosening and complications:
 - Extreme weakening of the bone structure in preparing the bone bed;
 - Unsuitable selection of the implant size;
 - Inadequate cleaning of the bone bed prior to implantation; and,
 - Excessive use of force in placing or fastening the implant, provoking splintering fractures, or causing the bone to tear.
11. This is a single use device. Reuse of this device could result in failure of the device to perform as intended and could cause harm to the patient and/or user.
12. Do not re-sterilize this device.
13. The operation is to be planned based on the pre-operative X-rays.
14. The specific Arthrex implantation instruments are to be used both for preparing the bone bed and for adjusting and inserting the joint prosthesis. The appropriate Arthrex delivery system is required for proper insertion of the implant.
15. Only Arthrex delivery systems, instruments, and trial prostheses should be used for the implantation procedure.
16. Endoprostheses may not be processed mechanically or changed in any other way.
17. Do not implant any parts that have been scratched or damaged. An artificial joint is subject to wear and/or can loosen over a period of time. Wear and loosening may make it necessary to re-operate on an artificial joint.
18. An infection in an artificial joint may lead to implant removal.
19. This device should only be used in conjunction with other implants designed specifically for use with this system.
20. Proper anchoring is of decisive importance for firm, permanent positioning of the prosthesis.
21. CaP coated device – Fluid contact other than patient’s blood should be avoided to achieve the best on growth results.
22. In the case of joint endoprosthesis intended for cemented anchoring, the surgeon must comply with the instructions and recommendations of the cement manufacturer when it comes to preparation and cementing techniques. Failure to properly align and completely seat the components together can lead to disassociation. Proper technique must be followed to ensure there is no bony or soft tissue interference between modular components. All screws must be adequately tightened to ensure they are recessed to prevent a mechanical interference between modular components.
23. Thoroughly clean and dry tapers, prior to attachment of modular components to avoid crevice corrosion and improper seating. Glenosphere forceps are required to verify integrity of the Morse taper connection between glenosphere and baseplate.
24. Biohazard waste, such as explanted devices, needles and contaminated surgical equipment, should be safely disposed of in accordance with the institutions policy.
25. Serious incidents should be reported to Arthrex Inc., or an in-country representative, and to the health authority where the incident occurred.

MRI (Magnetic Resonance Imaging) Safety Information

1. MR (Magnetic Resonance) Conditional



MRI Safety Information

A person with Arthrex implants may be safely scanned under the following conditions. Failure to follow these conditions may result in injury.

Device Family	Uniers Revers Shoulder Prosthesis System
Static Magnetic Field Strength (B0)	1.5T or 3.0T
Maximum Spatial Field Gradient	30 T/m or 3000 gauss/cm
RF (Radio Frequency) Excitation	Circularly Polarized (CP)
RF Transmit Coil Type	Volume RF body coil
Operating Mode	Normal Operating Mode
Maximum Whole-Body SAR (Specific Absorption Rate)	0.5 W/kg (Normal Operating Mode)
Maximum Head SAR	N/A
Scan Duration	Under the scan conditions defined the Arthrex Shoulder System can be scanned continuously for 60 minutes.
MR Image Artifact	The presence of this implant may produce an image artifact of 60 mm.

Patients who have other MR Conditional devices can be scanned as long all the MR Conditional scan parameters for each of the devices are met. Do not conduct an MRI scan if any conditions for safe scanning for any device cannot be met.

If information about a specific parameter is not included, there are no conditions associated with that parameter.



This description of technique is provided as an educational tool and clinical aid to assist properly licensed medical professionals in the usage of specific Arthrex products. As part of this professional usage, the medical professional must use their professional judgment in making any final determinations in product usage and technique. In doing so, the medical professional should rely on their own training and experience and should conduct a thorough review of pertinent medical literature and the product's directions for use. Postoperative management is patient-specific and dependent on the treating professional's assessment. Individual results will vary and not all patients will experience the same postoperative activity level and/or outcomes.

arthrex.com

© 2024-05 Arthrex, Inc. All rights reserved. LT1-000175-en-US_L



Arthrex manufacturer,
authorized representative,
and importer information
(Arthrex eIFUs)



US patent information